

# Installation Instructions

I - Sheet Number BF21 Rev.A



AUTO VENT SHADE™

## Bugflector® - Bugflector II® - Carflector®

For proper installation and best possible fit, please read all instructions **BEFORE** you begin.  
For technical assistance or to obtain missing parts, please call Customer Relations at 1-800-241-7219.

### Important Safety Information



- CAUTION - Before driving, ensure that the hood shield is properly secured to vehicle.
- Do not use automatic "brush-style" car washes.
- Do not use cleaning solvents of any kind.
- Periodically check all components for tightness.

### Contents **NOTE:** Actual product may vary from illustration.

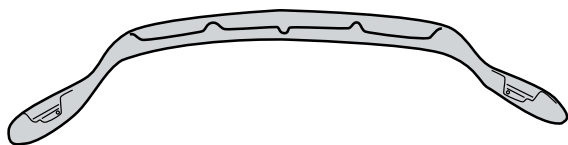

Hood Shield

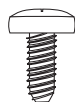

Phillips Screw x2



Plastic Washer x2



Fastener x2



Bump On x4

### Tools Required



Car Wash Supplies



Clean Towel

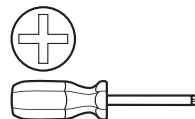

Phillips Screwdriver

### Preparation Before Painting / Installation

- A trial fit is recommended to ensure proper positioning and fit.
- Check fit of parts before painting as we will not accept the return of modified or painted parts.
- Wash and dry your vehicle to remove any debris and/or dirt from the installation area.

### Installation Steps **NOTE:** Actual application may vary slightly from illustrations.

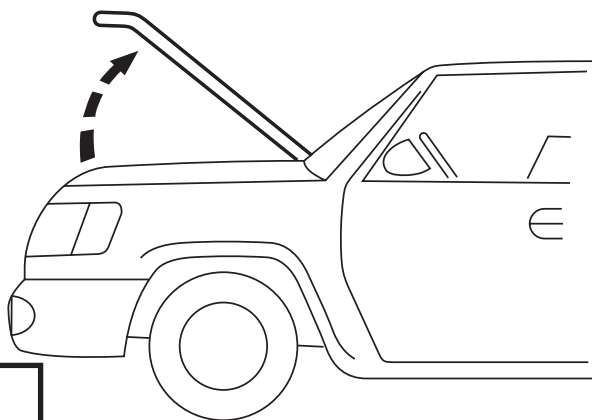

1

Locate (4) mounting positions on underside of hood.

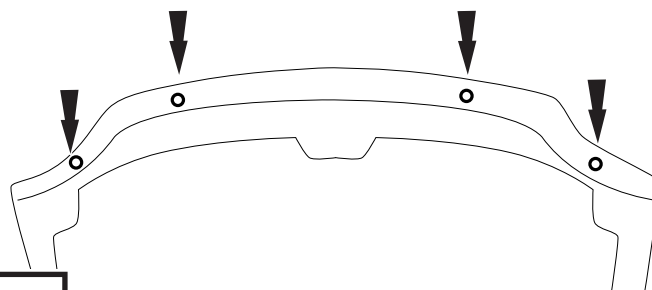

2

# Installation Steps

**NOTE:** Actual application may vary slightly from drawings.

Remove (2) fasteners which attach rubber trim to hood.

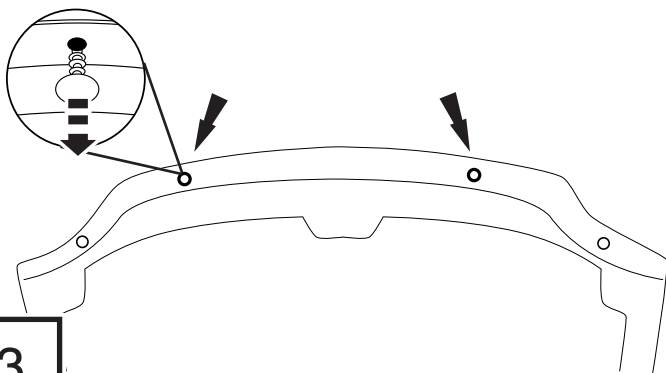

3

Align Hood Shield with holes in hood. The mounting flange of the hood shield is positioned **OVER** the rubber trim.

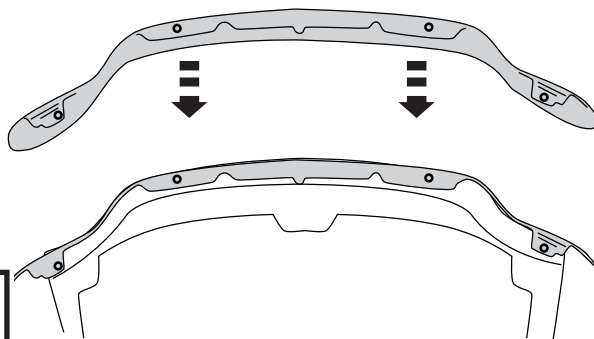

4

Install (2) screws with washers in the outboard mounting holes.

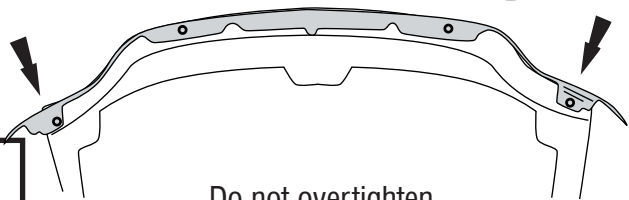
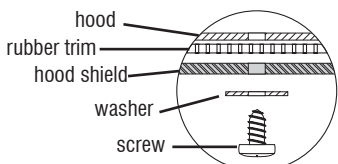
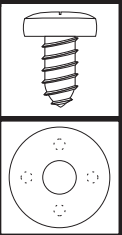

5

Do not overtighten

Install (2) plastic fasteners in the inboard mounting holes.

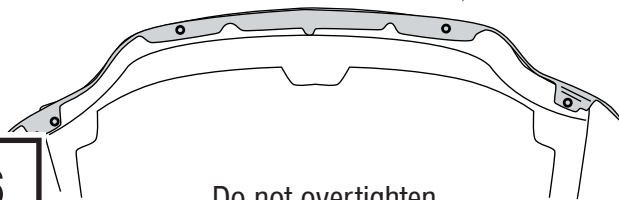
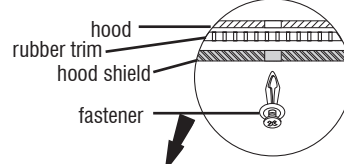
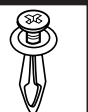

6

Do not overtighten

Install (4) bump ons.

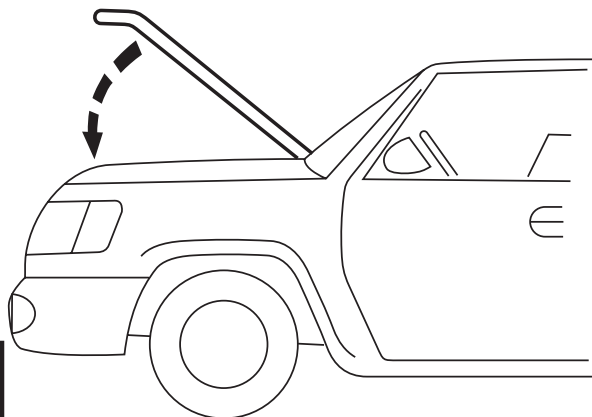
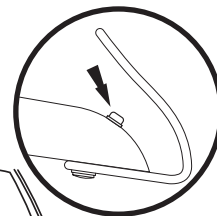

7

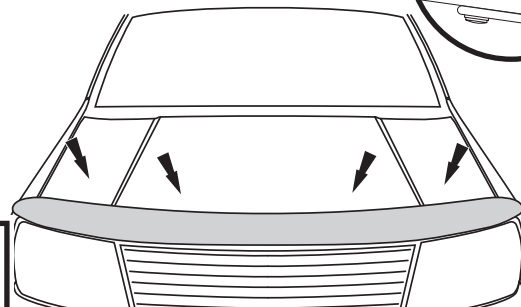

8

## Care and Cleaning

- Wash only with mild soap & dry with a clean cloth.

## Congratulations!

You have purchased one of the many quality Auto Ventshade™ branded products offered by Lund International, Inc. We take the utmost pride in our products and want you to enjoy years of satisfaction from your investment. We have made every effort to ensure that your product is top quality in terms of fit, durability, finish and ease of installation.



Lund International, Ventshade Accessories Division  
655 Raco Drive, Lawrenceville, GA 30045

800-241-7219 • Fax 770-339-5839 • Visit us at [lundinternational.com](http://lundinternational.com)

© 2005 Lund International, Inc. All rights reserved.

Auto Ventshade™, the Auto Ventshade™ logo and the AVS™ logo are trademarks of Lund International, Inc.





## Bugflector® - Bugflector II® - Carflector®

Pour obtenir une installation correcte et le meilleur ajustement possible, lire toutes les instructions AVANT de commencer. Pour toute assistance technique ou obtention de pièces manquantes, appeler le service des relations avec la clientèle au 1-800-241-7219.

### Informations importantes concernant la sécurité



- ATTENTION – Avant de conduire, s'assurer que le pare-insectes est solidement assujettie sur le véhicule.
- Ne pas utiliser les stations de lavage de voitures à brosse.
- Ne pas utiliser de solvants.
- Vérifier régulièrement le serrage des composants.

### Contenu **NOTE:** Le produit réel peut changer de l'illustration.

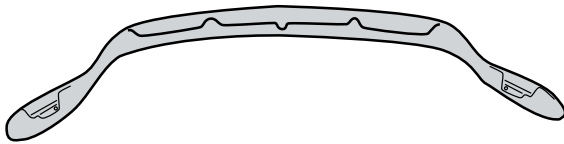

Pare-insectes

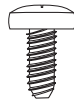

Vis Phillips  
(2)



Rondelle En plastique  
(2)



Attache (2)



Butoirs (4)

### Outils nécessaires



Fournitures pour lavage de  
voiture

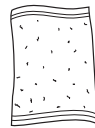

Serviette propre

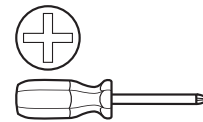

Tournevis Phillips

### Préparation pour la peinture/l'installation

- Il est recommandé de procéder à un essai pour s'assurer que le positionnement et l'ajustement sont corrects.
- Vérifier l'ajustement des pièces avant peinture, car nous n'acceptons pas le retour de pièces modifiées ou peintes.
- Laver les glissières de glaces de la portière du véhicule pour éliminer toute poussière et tous débris.
- Sécher les glissières avec une serviette propre.

### Étapes d'installation

**REMARQUE :** La méthode d'application peut être légèrement différente de celle représentée par les illustrations.

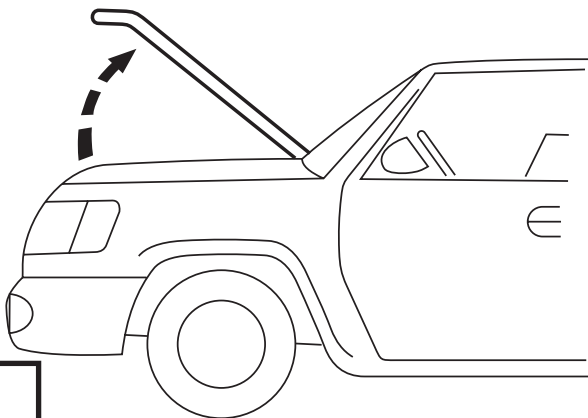

1

Localiser les (4) positions de montage du dessous du capot.

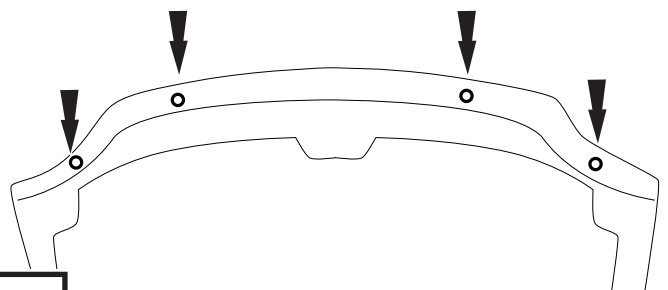

2

# Étapes d'installation

REMARQUE : La méthode d'application peut être légèrement différente de celle représentée par les illustrations.

Retirer les (2) fixations qui retiennent la garniture en caoutchouc sur le capot.

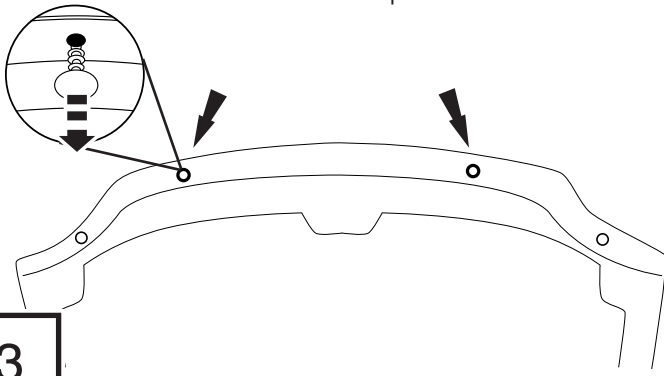

Aligner le pare-insectes et les trous du capot. La collerette de montage du pare-insectes se place **AU-DESSUS** de la garniture en caoutchouc.

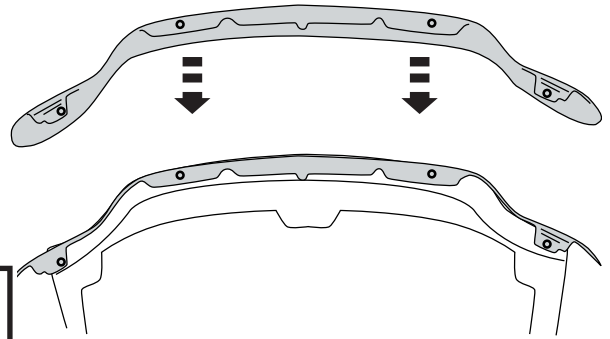

3

4

Installer (2) vis avec des rondelles sur les trous de fixation extérieurs.

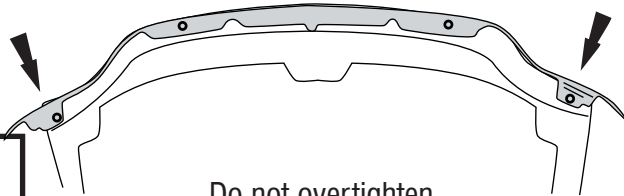
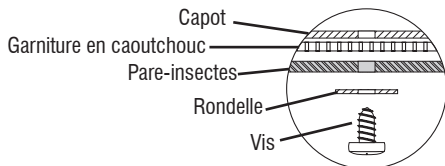
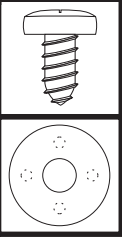

Do not overtighten

Installer (2) fixations en plastique dans les trous de fixation intérieurs.

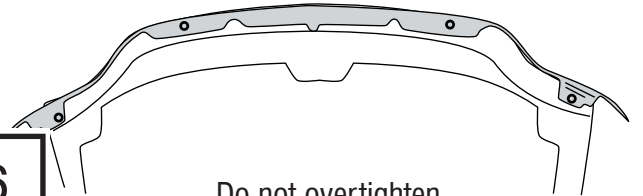
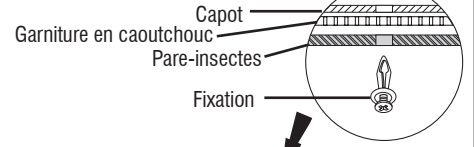
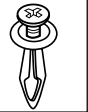

Do not overtighten

5

6

Installer (4) butoirs.

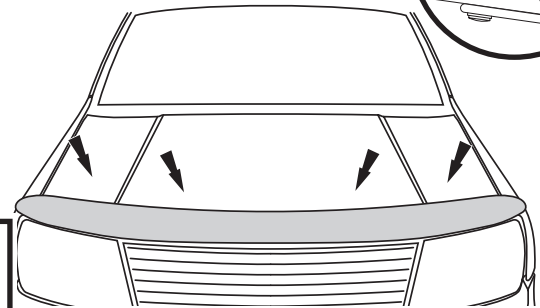
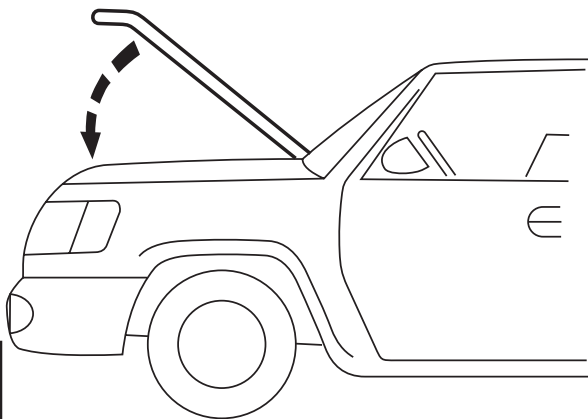
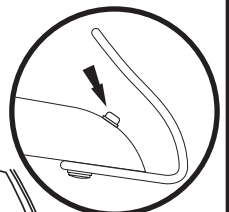

7

8

## Entretien et nettoyage

- Laver exclusivement avec de l'eau savonneuse et sécher avec un chiffon propre.

## Félicitations !

Vous avez acheté l'un des nombreux produits de qualité Auto Ventshade™ fabriqués par Lund International, Inc. Nous sommes extrêmement fiers de nos produits et souhaitons que vous tiriez des années de satisfaction de votre investissement. Nous avons pris toutes les mesures nécessaires pour assurer que ce produit est d'une qualité supérieure en ce qui concerne l'ajustement, la durabilité, la finition et la facilité d'installation.



AUTO VENTSHADE™  
Lund International, Ventshade Accessories Division  
655 Raco Drive, Lawrenceville, GA 30045, USA  
800-241-7219 • Fax 770-339-5839 • Visitez notre site [lundinternational.com](http://lundinternational.com)

© 2005 Lund International, Inc. Tous droits réservés.

Auto Ventshade™, le logo Auto Ventshade™ et le logo AVS™ sont des marques déposées de Lund International, Inc.





## Bugflector® - Bugflector II® - Carflector®

Para una instalación adecuada y el mejor ajuste posible, lea todas las instrucciones ANTES de comenzar. Si desea recibir asistencia técnica u obtener piezas faltantes, llame al Servicio al cliente al 1-800-241-7219.

### Información importante de seguridad



- PRECAUCIÓN - Antes de conducir, asegúrese de que la visera deflectora esté correctamente anclada al vehículo.
- No utilice servicios automáticos de limpieza de vehículos que utilizan cepillos.
- No utilice limpiadores al solvente de ningún tipo.
- Compruebe periódicamente que todos los componentes estén ajustados.

### Contenido **NOTA:** El producto real puede variar de la ilustración.

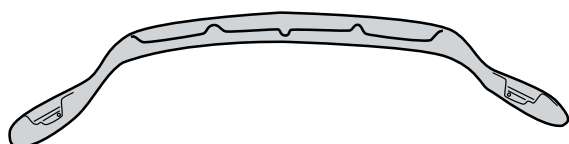

Cubierta para capó

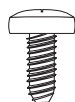

Tornillo Phillips (2)

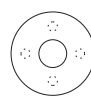

Arandela Plástica (2)



Sujetador (2)



Soporte (4)

### Herramientas necesarias



Equipo de limpieza de vehículos



Toalla limpia

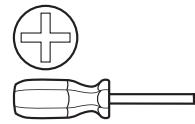

Destornillador Phillips

### Preparación antes de pintar o instalar

- Se recomienda realizar un ajuste de prueba para asegurar el posicionamiento y ajuste correctos.
- Compruebe que las piezas se ajusten correctamente antes de pintarlas, ya que no aceptaremos la devolución de piezas modificadas o pintadas.
- Lave los canales de la ventanilla del vehículo para quitar los desechos y la suciedad.
- Seque los canales de la ventanilla con una toalla limpia.

### Pasos de instalación **NOTA:** El uso real puede variar levemente de ilustraciones.

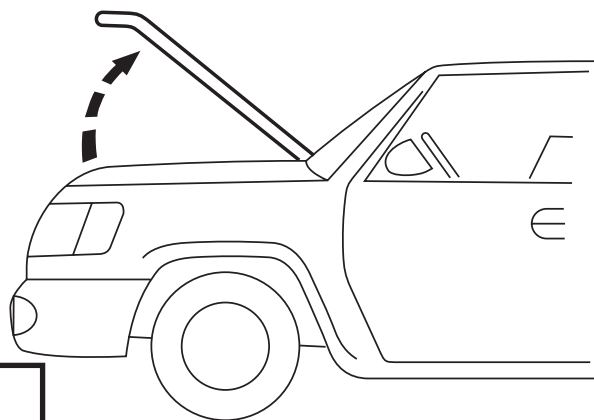

1

Ubique los (4) lugares de colocación en la parte inferior del capó.

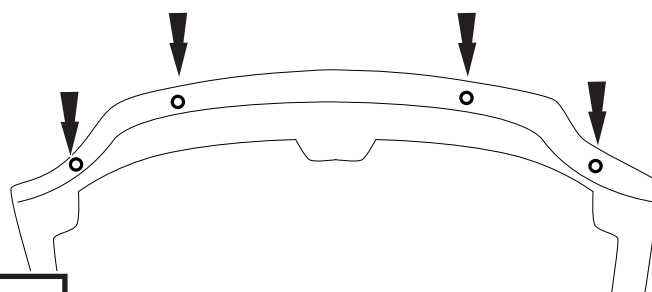

2

## Pasos de instalación

**NOTA:** El uso real puede variar levemente de ilustraciones.

Quite los (2) sujetadores que ajustan la banda de goma al capó.

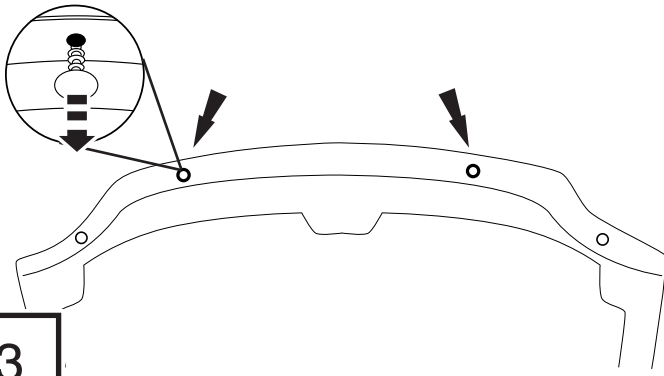

3

Alinee los orificios de la cubierta para capó con los orificios en el capó. El reborde de colocación de la cubierta para capó se coloca **SOBRE** la banda de goma.

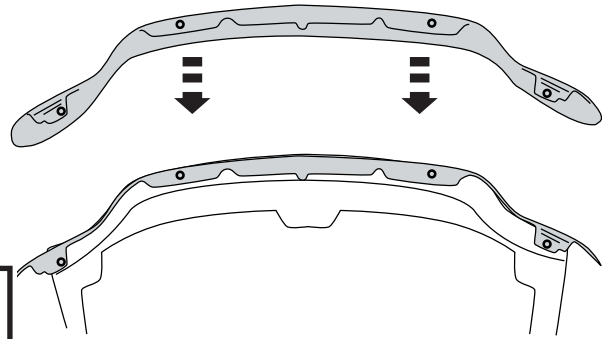

4

Coloque (2) tornillos con arandelas en la parte exterior de los orificios de colocación.

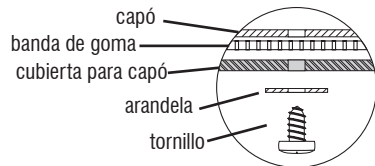
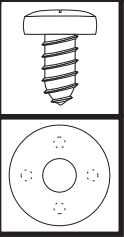

5

Do not overtighten

Coloque (2) sujetadores plásticos en la parte interior de los orificios de colocación.

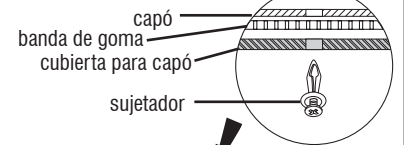
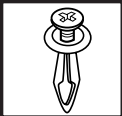

6

Do not overtighten

Coloque (4) soportes.



7

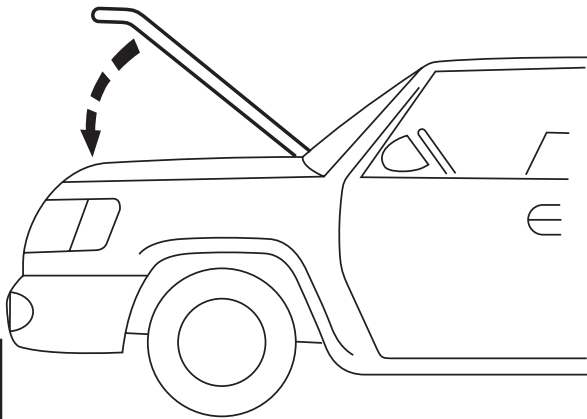

8

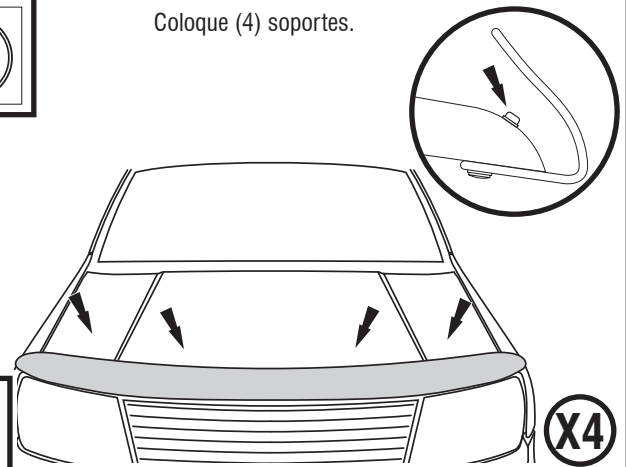

## Cuidado y limpieza

- Limpie solamente con agua jabonosa tibia y seque con un paño limpio.

## Felicidades

Usted ha comprado uno de los tantos artículos de calidad de Auto Ventshade™ ofrecidos por Lund International, Inc. Nuestros productos son nuestro mayor orgullo. Deseamos que disfrute de años de satisfacción con su inversión. Hemos realizado todos los esfuerzos para asegurarnos de que su producto sea de la mejor calidad en cuanto a ajuste, durabilidad, acabado y facilidad de instalación.



AUTO VENTSHADE™

Lund International, Ventshade Accessories Division

655 Raco Drive, Lawrenceville, GA 30045

800-241-7219 • Fax 770-339-5839 • Visite nuestro sitio Web: [lundinternational.com](http://lundinternational.com)

© 2005 Lund International, Inc. Todos los derechos reservados.



Auto Ventshade™, el logo de Auto Ventshade™ y el logo de AVS™ son marcas comerciales de Lund International, Inc.

