



AIRCHARGER™

HIGH-FLOW INTAKE KITS



INSTALLATION INSTRUCTIONS

63-9032-1
TOYOTA
2007-09 TUNDRA
2008-09 SEQUOIA
V8-4.7L

NOTE: This kit was not designed to fit vehicles with a body lift.

TOOLS NEEDED:
 Ratchet, Extension,
 10mm Socket, 10mm
 Wrench, 9/16" Wrench,
 5/8" Wrench, Flat Blade
 Screw Driver, Phillips
 Screw Driver, 4mm Allen
 Wrench, 2.5 mm Allen
 Wrench

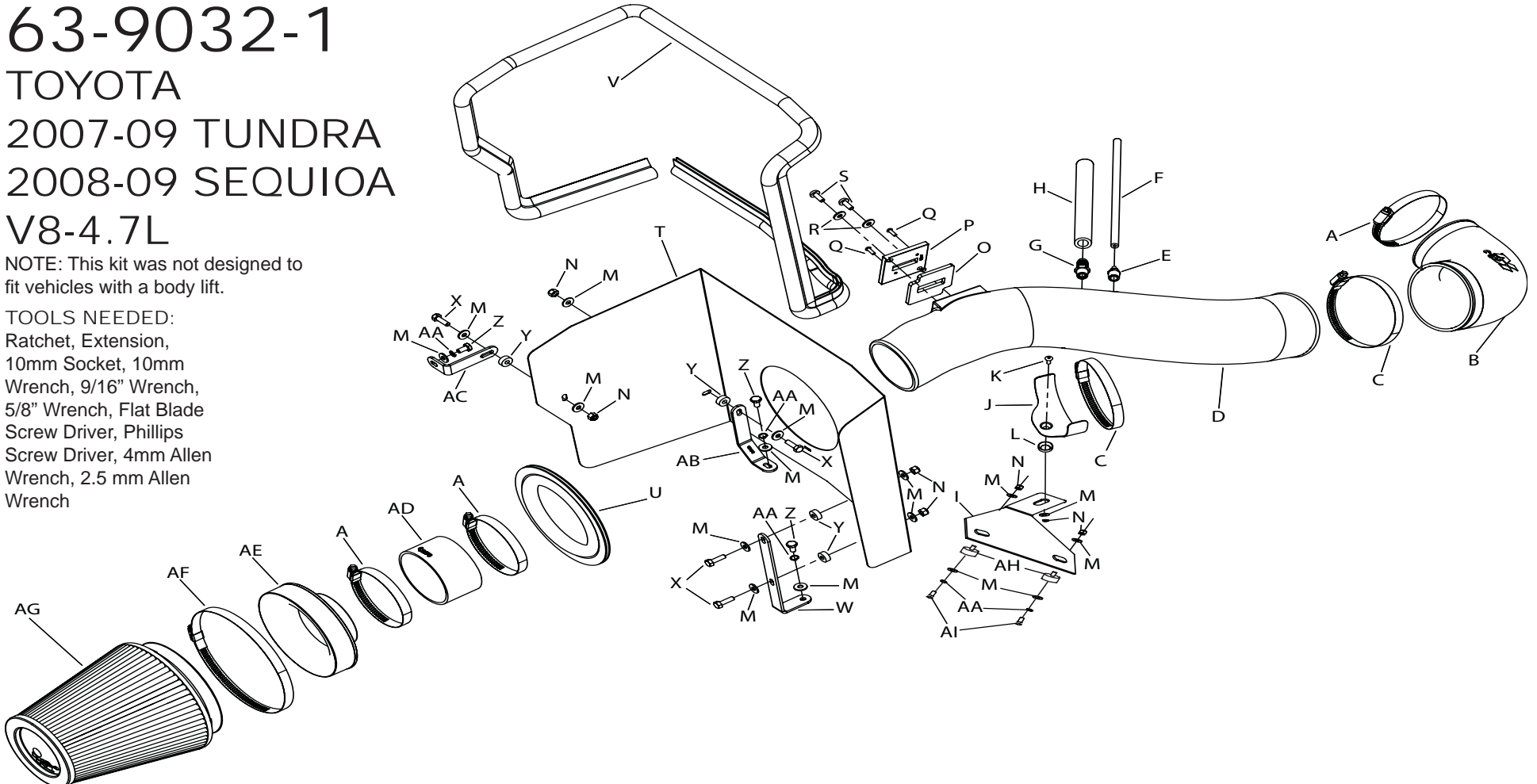

PARTS LIST:

Desc.	QTY.	Part#	Desc.	QTY.	Part#	Desc.	QTY.	Part#
A Hose Clamp #56	3	08620	M Washer; 1/4" ID X 5/8" OD-SAE	16	08275	Y Spacer; .625"ODX.250"IDX.250" L	4	06555
B Hose; 3-1/2" ID < 4" ID Elbow	1	084086	N Nut; 6mm Nylock, Hexhead, SS	7	07512	Z Bolt; 6mm-1.00 X 16mm, SS	3	07812
C Hose Clamp #64 Stainless	2	08645	O Gasket; 3/16 Poron	1	09069	AA Washer; 1/4" Lock, ZN	5	08198
D Intake Tube	1	087216	P Adaptor; Nylon 6/6 GF, Black	1	21515	AB Bracket; Mid Stl FB/PC	1	07190
E Vent;STRT 1/2" 3/16 Brb, 1/4 NPT	1	080021	Q Screw; M4-.7 X 12. Buttonhead	2	07726	AC Bracket; "L"	1	070742
F Hose; 12" 4mm	1	08147	R Washer, 6mm Flat, SS	2	08269	AD Hose; 3.5" ID X 2" L, Blk Silcn	1	08630
G Vent; STRT 1/2" Hose, 1/4" NPT	1	080022	S Bolt; M6 X 1.00 X 16mm, BTNHD	2	07730	AE Adaptor; #380	1	21512
H Hose; 1/2" ID X 9"L,	1	08401	T Heat Shield	1	07653-1	AF Hose Clamp #104	1	08697
I Bracket; "L" Stl, FB/PC	1	083128	U Edge Trim (20")	1	102494	AG Air Filter	1	RF-1041
J Bracket; Saddle, S/S	1	078855	V Edge Trim (75")	1	102460	AH Stud; M/F,1/2"LX1"W,M6X1.00	2	070228
K Bolt; 6mm-1.00 X 20mm F/H/A SS	1	08376	W Bracket; "L" Bend	1	070902	AI Bolt;M6X1.00X12MM,HEXHEAD	2	07727
L Washer; Conical, Nylon, Black	1	08180	X Bolt; M6 X 1.00 X 20mm, Hex, SS	4	07795			

NOTE: FAILURE TO FOLLOW INSTALLATION INSTRUCTIONS AND NOT USING THE PROVIDED HARDWARE MAY DAMAGE THE INTAKE TUBE, THROTTLE BODY, AND ENGINE.

TO START:

1. Turn the ignition off and disconnect the vehicle's negative battery cable.

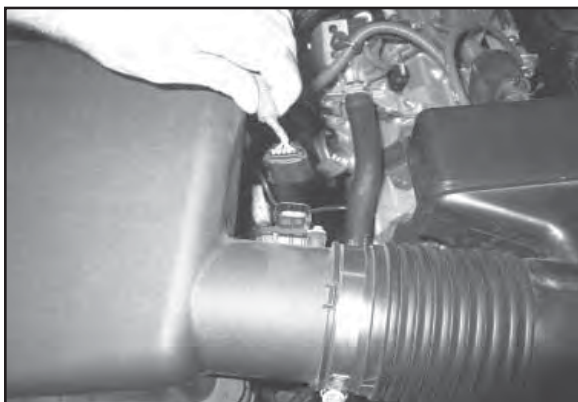

2. Disconnect the mass air sensor electrical connection, then unclip the mass air sensor wiring from the air box.



3. Remove the two factory nuts that retain the engine cover. Remove the engine cover.



4. Loosen the hose clamp that secures the stock intake tube to the throttle body.

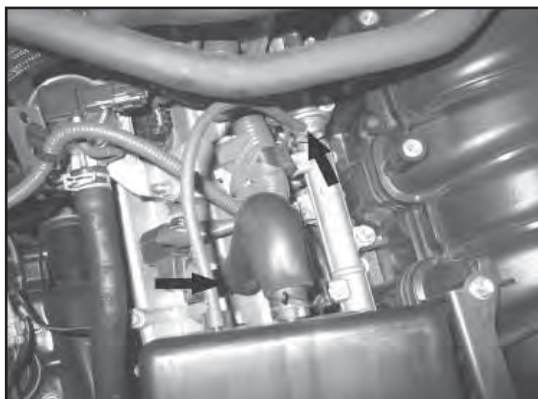

5. Disconnect the fuel pressure regulator hose from the fuel pressure regulator. Disconnect the crank case vent hose from the valve cover.



6. Release the four upper air box clam shell clamps, then remove the upper air box and intake tube assembly.



7. Remove the two factory bolts that secure the lower air box to the inner fender.

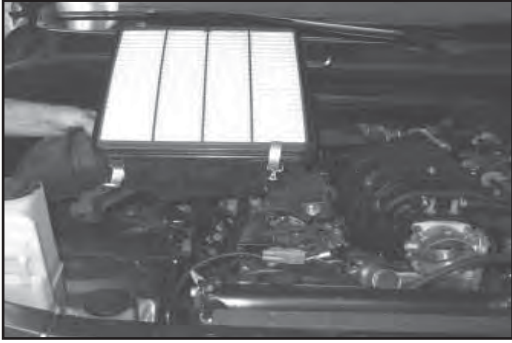

8. Lift the air box up, releasing it from the inner fender mounting grommet and fresh air duct. Remove the lower air box from the vehicle.

Note: K&N recommends that customers do not discard factory air intake.



9. Install the small "L" bracket (#070742) onto the inner fender, behind the hood support. Secure with the provided hardware as shown.

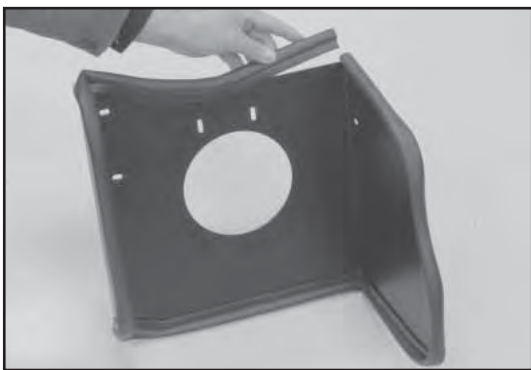

10. Install the long edge trim onto the heat shield as shown.

Note: Some trimming of the edge trim may be necessary.

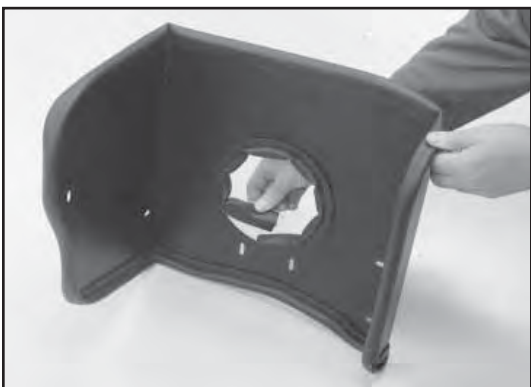

11. Install the short edge trim into the hole in the heat shield as shown.

Note: Some trimming of the edge trim may be necessary.

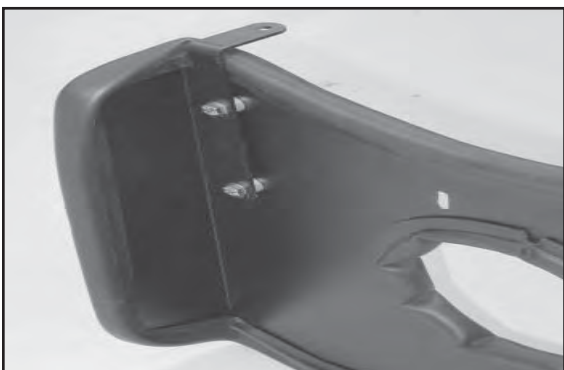

12. Install the long "L" bracket (#070902) onto the heat shield with the provided hardware as shown. **Note: Place two of the provided spacers between the bracket and heat shield, one on each bolt.**

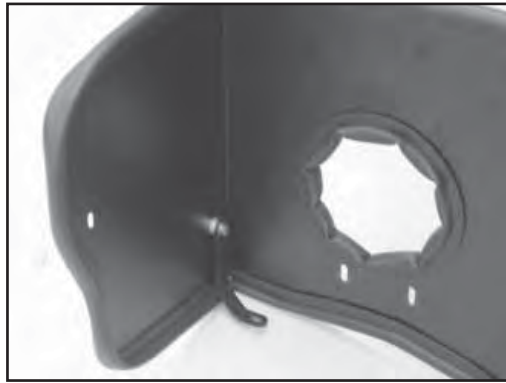

13. Install the provided "C" bracket onto the heat shield with the provided hardware as shown.

Note: One provided spacer is to be placed between the bracket and heat shield.

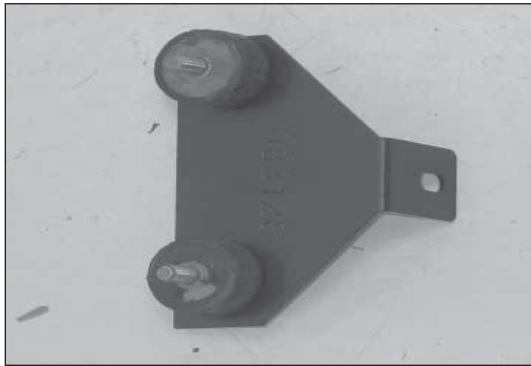

14. Secure the provided rubber mounted studs to the tube mounting bracket as shown using the provided hardware.

NOTE: Do not completely tighten at this time.

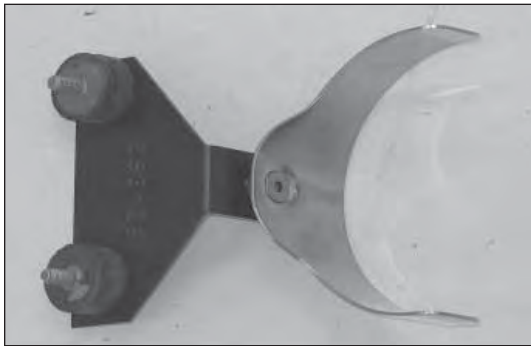

15. Install the saddle clamp onto the tube mounting bracket as shown using the provided hardware.

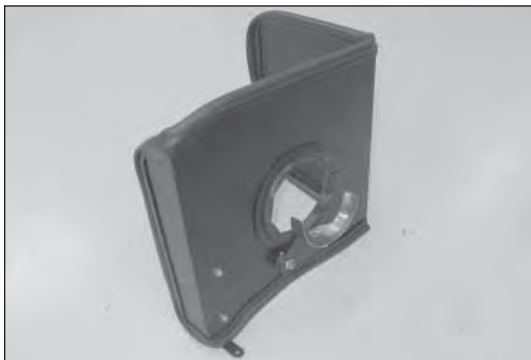

16. Install the tube mounting bracket assembly onto the heat shield as shown using the provided hardware.

NOTE: Do not completely tighten at this time.

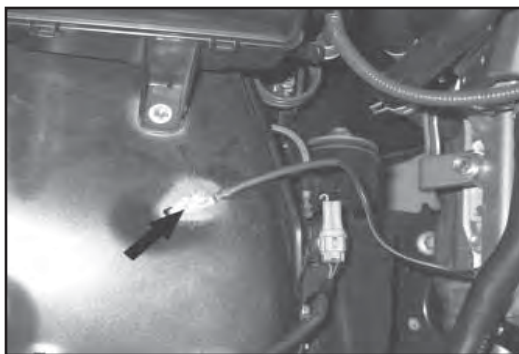

17. Remove the bolt that retains the ground strap to the inner fender.



18. Set the heat shield into position on the inner fender. Secure the "C" bracket to the ground strap location.

Note: The ground strap is to be installed under the "C" bracket, in its original location.

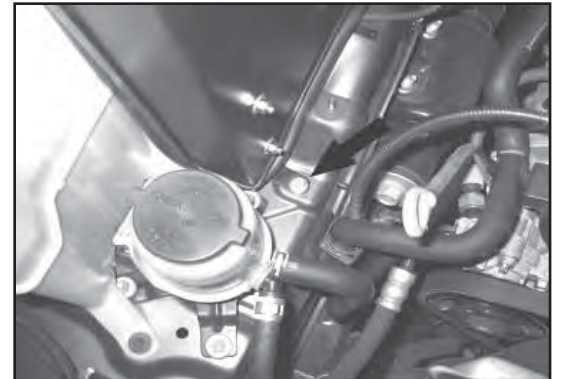

19. Secure the front heat shield bracket to the front air box location with the provided hardware.

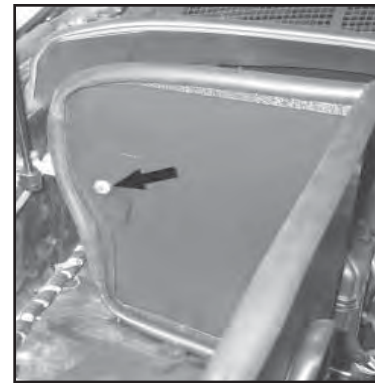

20. Secure the rear of the heat shield to the bracket installed in step #12.

Note: One provided spacer is to be placed between the bracket and heat shield.

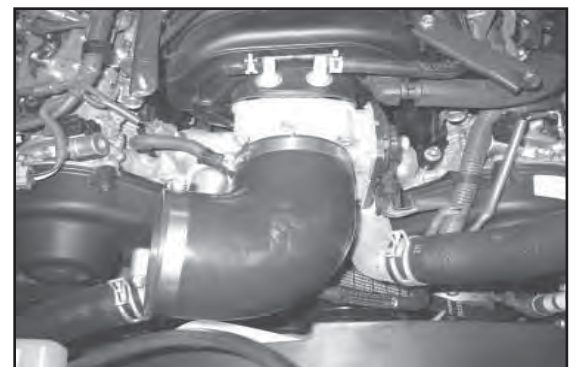

21. Install silicone hose (#084086) onto the throttle body and secure with the provided hose clamp.

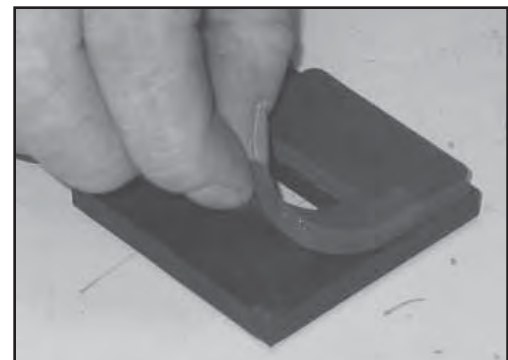

22. Install the provided gasket onto the K&N mass air sensor adapter as shown.

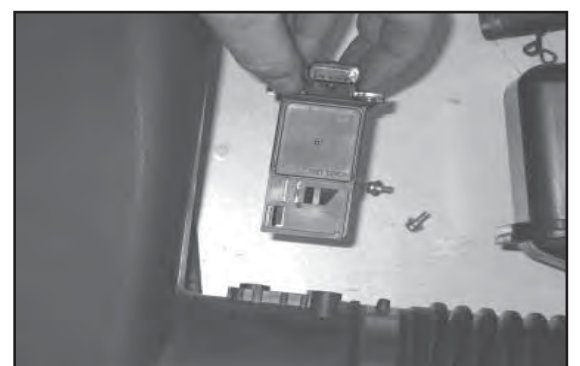

23. Remove the two factory screws that secure the mass air sensor, then remove the mass air sensor from the stock intake tube.

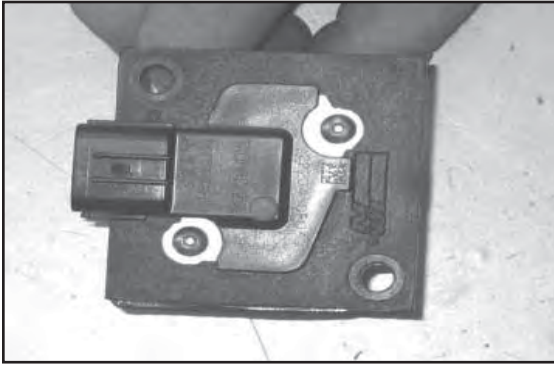

24. Install the mass air sensor into the K&N mass air sensor adapter and secure with the provided hardware.

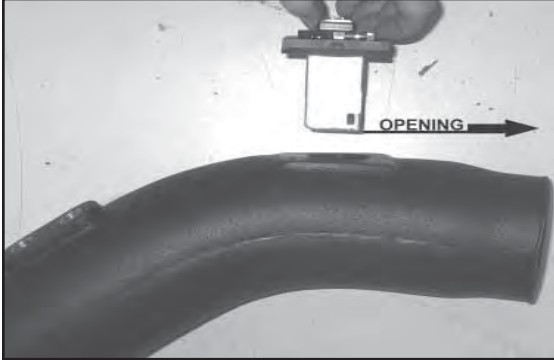

25. Install the mass air sensor assembly into the K&N intake tube and secure with the provided hardware.

Note: The opening in the mass air sensor is to be installed facing towards the inlet end of the tube.

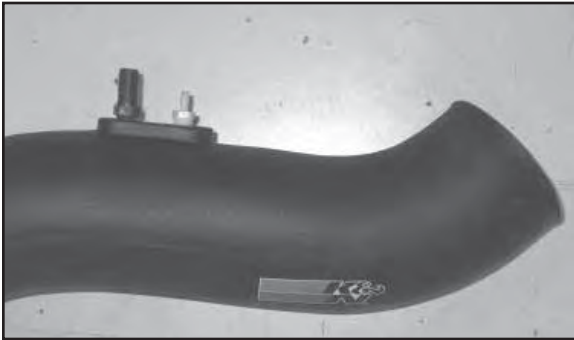

26. Install the provided 1/4" NPT fittings into the K&N intake tube as shown.

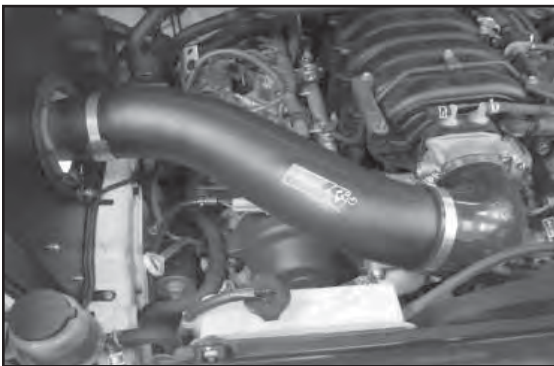

27. Install the K&N intake tube into the silicone hose at the throttle body and align with the tube mounting bracket installed in step #11. Secure the intake tube with the provided hose clamps.

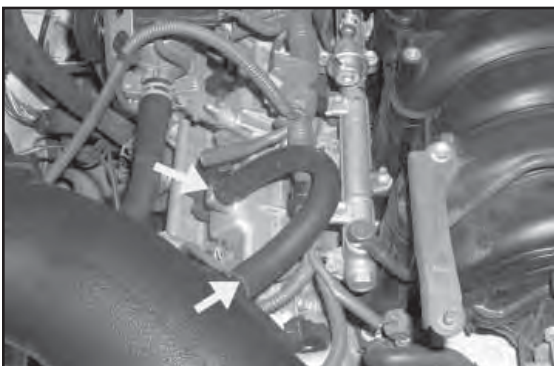

28. Install the provided crank case vent hose onto the valve cover fitting, then connect the open end to the NPT fitting installed into the K&N intake tube as shown.

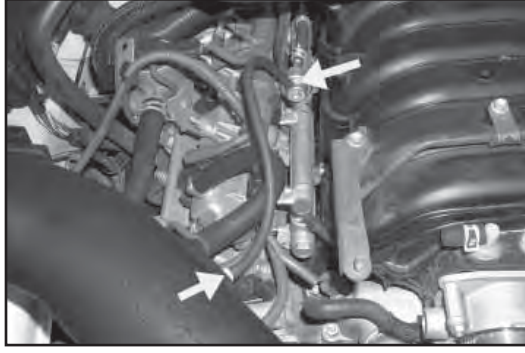

29. Install the provided fuel pressure hose onto the fuel pressure regulator, then connect the open end to the NPT fitting installed into the K&N intake tube as shown.



30. Install the provided air filter adapter into the K&N air filter and secure with the provided hose clamp as shown.

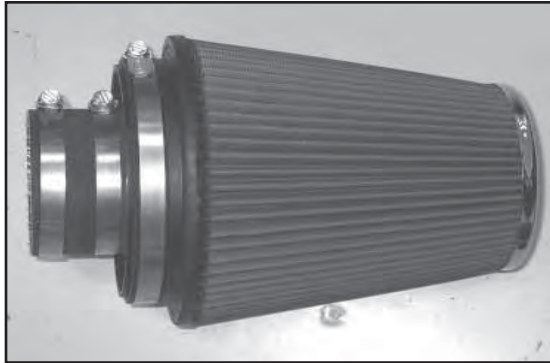

31. Install silicone hose (#08630) onto the air filter adapter and secure with the provided hose clamp.

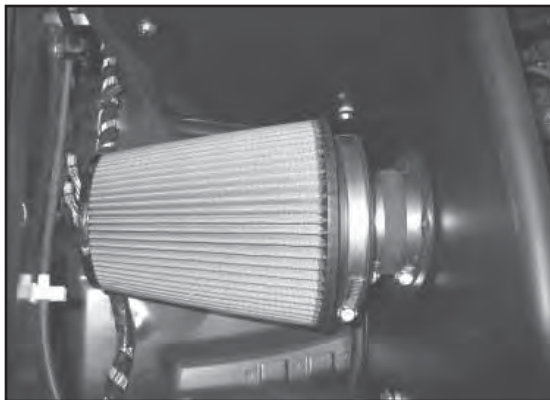

32. Install the K&N air filter assembly onto the K&N intake tube and secure with the provided hose clamp as shown.

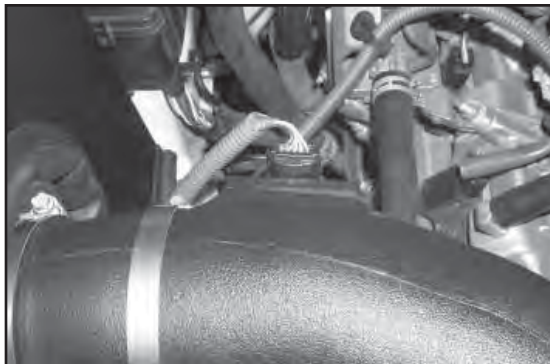

33. Re-connect the mass air sensor electrical connection.

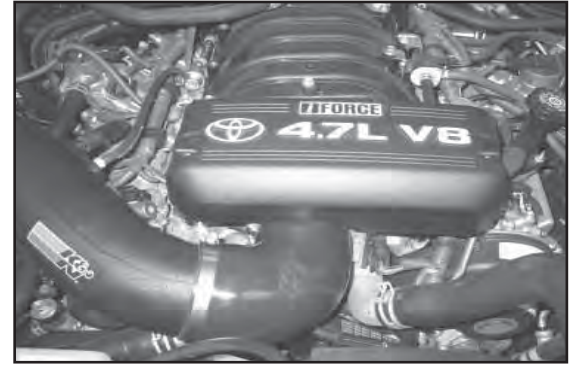

34. Re-install the engine cover and secure with the factory nuts.



35. Re-connect the vehicle's negative battery cable. Check to ensure everything is tight and properly positioned before starting the vehicle.

36. It will be necessary for all K&N intake kits to be checked periodically for re-alignment, clearance, and tightening of all connections. Failure to follow the above instructions and/or improper maintenance may void the warranty.

Road Testing

1. Start the engine with the transmission in neutral or park, and the parking brake engaged. Listen for air leaks or odd noises. For air leaks secure hoses and connections. For odd noises, find cause and repair before proceeding. This kit will function identically to the factory system except for being louder and much more responsive.

2. Test drive the vehicle. Listen for odd noises or rattles and fix as necessary.

3. If road test is fine, you can now enjoy the added power and performance from your kit.

4. K&N suggests checking the air filter element periodically for excessive dirt build-up. When the element becomes covered in dirt (or once a year), service it according to the instructions on the Recharger service kit, part number 99-5050 or 99-5000.

STREET LEGAL IN MOST STATES

**NOT LEGAL FOR USE IN CA & OTHER STATES
ADOPTING CA EMISSIONS STANDARDS**

See our catalog or knfilters.com for CARB status on each part for a specific vehicle

FREE K&N DECAL To register your warranty, please see us online at knfilters.com/register. FREE K&N DECAL