



INSTALLATION INSTRUCTIONS

57-2530

Ford

1999-03 F-Series SuperDuty

2000-03 Excursion

V8-7.3L Turbo Diesel

NOTE: This kit was not designed to fit vehicles with a body lift.

TOOLS NEEDED:

- 5/16" Wrench
- Flat blade screwdriver
- 4mm Allen wrench
- 10mm Wrench
- 7/16" Wrench

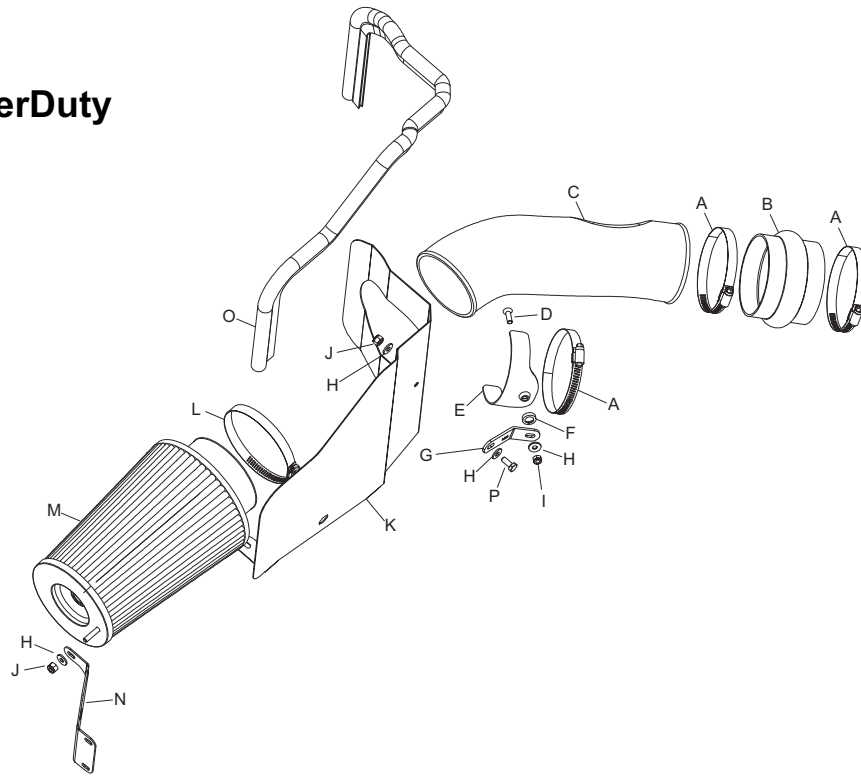

PARTS LIST:

A	Hose clamp #60	3	08624
B	Hump hose	1	08418
C	Intake tube	1	087012
D	Bolt, 6mm, F/H/A	1	08376
E	Saddle bracket	1	078855
F	Washer, conical, black	1	08180
G	Bracket	1	070010
H	Washer, 1/4"ID x 5/8"OD SAE	4	08275
I	Nut, 6mm nylock	1	07553
J	Nut, 1/4-20 nylock zinc	2	07517
K	Heat shield	1	07443
L	Hose clamp #72	1	08671
M	Filtercharger element	1	RC-4780
N	Filter bracket	1	070020
O	Edge trim, 35"L	1	102471
P	Bolt, 1/4-20 x 5/8" hexhead	1	08315

TO START:

1. Turn the ignition OFF and disconnect the vehicle's negative battery cable.



2. On 2002 models disconnect the restrictor gauge electrical connection as shown.



3. Loosen the hose clamp at the intake manifold. Release the clips from airbox top then remove complete upper intake.

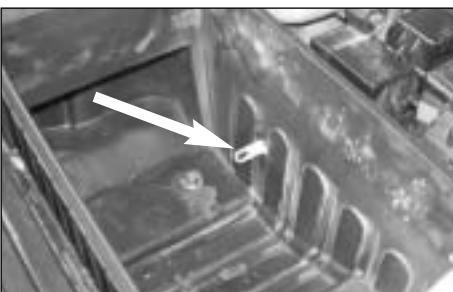

4. Remove the air temp sensor from the airbox.

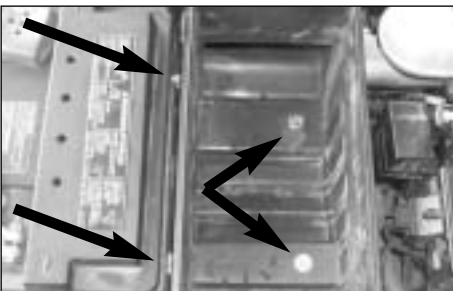

5. Loosen and remove the 4 bolts that retain the stock airbox.

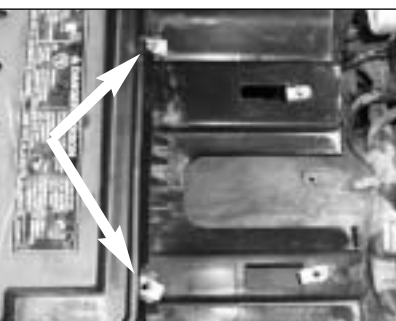

6. Remove the two upper airbox mounting clips.



7. Then remove the stock airbox base from vehicle.



8. Apply the edge trim to the heat shield as shown. Trim if needed.



9. Assemble the "L" bracket and saddle bracket as shown.



10. Install saddle bracket assembly onto heat shield as shown. Do not tighten completely.

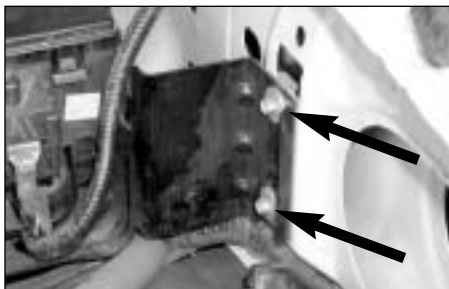

11. Remove the two bolts that retain the fuse box mounting bracket as shown.



12. Vehicles that are not equipped with the fuse box, use the two upper mounting clips that were removed in step 6 and install onto inner fender wall.



13. Install the silicone hump hose and hose clamps onto the K&N intake tube as shown.



14. Install the heat shield and saddle bracket assembly as shown.



15. Using the two bolts removed in step 5, secure the heat shield to stock airbox mounting location. Do not tighten completely.



16. Install the K&N intake tube onto intake manifold. **NOTE:** Make sure to keep clearance between intake tube and inner cooler pipe.



17. Install hose clamp onto saddle bracket and K&N intake as shown.

18. Adjust saddle bracket and heat shield for necessary clearance, then tighten all bolts.



19. Install air temp sensor to heat shield as shown.



20. Install filter bracket onto filter as shown, but do not tighten completely.

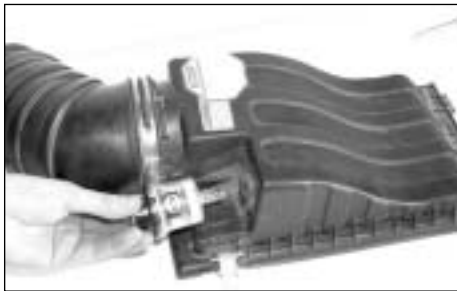

21. Remove air filter restriction gauge from stock airbox top.



22. Remove restriction gauge grommet from stock airbox top.

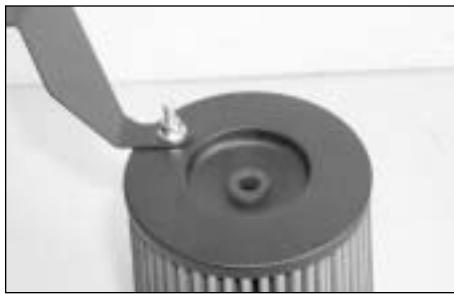

23. Install grommet into new Filtercharger element top as shown.



24. Install filter restriction gauge onto Filtercharger element top as shown.



25. Install Filtercharger element onto intake tube as shown but do not tighten completely.

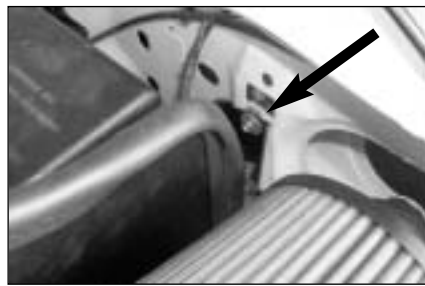

26. Now install the new filter bracket behind the fuse box mounting bracket as shown.



27. Adjust all brackets to obtain maximum clearance for intake tube and Filtercharger element then tighten completely. **NOTE:** make sure the Filtercharger is below the inner fender lip as shown for hood clearance.

28. On 2002 models re-connect restrictor gauge electrical connection that was removed in step 2.

29. Reconnect the vehicle's negative battery cable. Double check to make sure everything is tight and properly positioned before starting vehicle.

30. The C.A.R.B. exemption sticker, (attached), must be visible under the hood, so that an emissions inspector can see it when the vehicle is required to be tested for emissions. California requires testing every two years, other states may vary.

31. It will be necessary for all F.I.P.K.'s to be checked periodically for realignment, clearance and tightening of all connections. Failure to follow the above instructions or proper maintenance may void warranty.

ROAD TESTING:

1. Start the engine with the transmission in neutral or park, and the parking brake engaged. Listen for air leaks or odd noises. For air leaks secure hoses and connections. For odd noises, find cause and repair before proceeding. This kit will function identically to the factory system except for being louder and much more responsive.

2. Test drive the vehicle. Listen for odd noises or rattles and fix as necessary.

3. If road test is fine, you can now enjoy the added power and performance from your kit.

IMPORTANT:

Service air filter according to the K&N cleaning instructions (99-5050) when the indicator on the restriction gauge is in the 50 to 65% range. On vehicles that come with an electric restrictor gauge, you must read the gauge manually, do not wait until the dash light illuminates. Do not run the vehicle with the indicator above the 65% range, as damage to the air filter and or the engine could result.